

The information provided herein is from CONNELY Electronic Co., Ltd. and is confidential. Any disclosure to a party other than the recipient is prohibited. The intellectual properties and its rights contained herein, including but not limited to, trademarks, patents, copyrights, trade secrets, and technical know-how, are owned exclusively by CONNELY or its affiliates. Unauthorized use or reproduction of this document in any format or manner, CONNELY may enforce its intellectual property rights at its own discretion; failures or delays to exercise such rights does not constitute a waiver of such rights.

1 2 3 4 5 6 7 8

A	Dept
	Qty
DC	1
ED	1
IE	1
ISO	1
PD	1
R&D	1
SD	1
QA	1
QC	1
QF	1
B	
C	
D	
E	
F	
G	
H	

REV.	DESCRIPTION	DRAWN	CHECKED	APPROVED
A	NEW RELEASE	JLZ 01/18/21'		
B	DRAWING UPDATE	JLZ 05/24/24'		

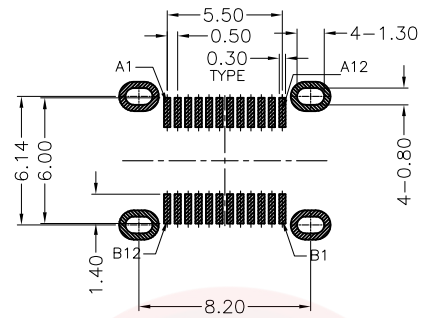
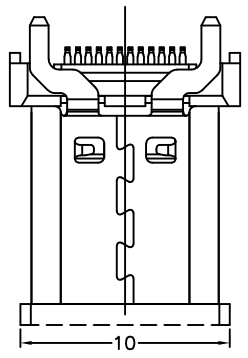

RECOMMEND P.C.B LAYOUT(COMPONENT SIDE)
TOLERANCE FOR PCB LAYOUT IS ± 0.05
KEEP OUT AREA

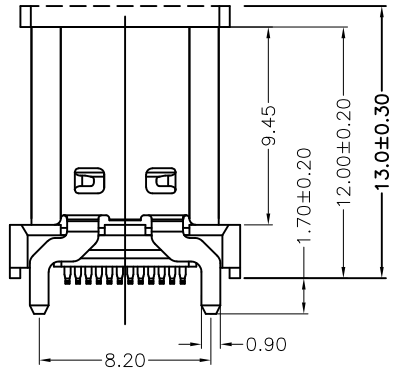
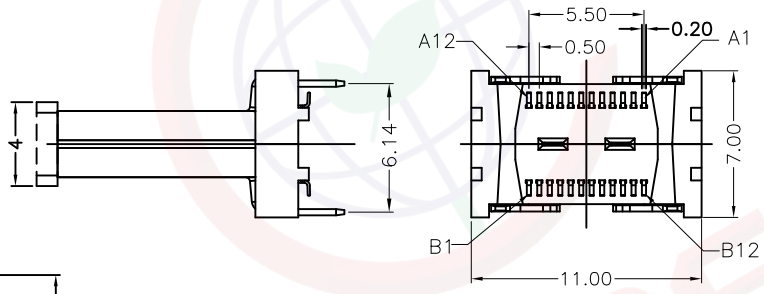
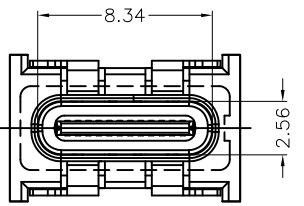

USB TYPE-C PIN ASSIGNMENTS

PIN NUMBER	SIGNAL NAME	PIN NUMBER	SIGNAL NAME
A1	GND	B12	GND
A2	TX1+	B11	RX1+
A3	TX1-	B10	RX1-
A4	Vbus	B9	Vbus
A5	CC1	B8	SBU2
A6	D+	B7	D-
A7	D-	B6	D+
A8	SBU1	B5	CC2
A9	Vbus	B4	Vbus
A10	RX2-	B3	TX2-
A11	RX2+	B2	TX2+
A12	GND	B1	GND

NOTE:
 1.Material specification:
 1-1. Housing:High temperature resistant plastic,UL94 V-0.
 1-2. Contacts:Copper alloy
 1-3. Shell: Stainless steel
 2.Electrical characteristics:
 2.1 Contact resistance: 40mΩ Max For initial. 10mΩ Change after test.
 Measure AT 20mV, 100mA.
 2.2 Contact current rating: 5A For collectively power supply Pin(PinA1,A4,A9,A12,B1,B4,B9,B12);
 1.25A For vconn pin; 0.25A For other signal pin.
 2.3 Dielectric withstanding voltage: 100V AC RMS.
 2.4 Insulation resistance: 100MΩ Min
 2.5 Operating temperature: -40°C ~ 85°C
 3.Product number code:
 DS1144-44 - X X X X X X X

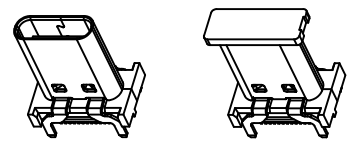
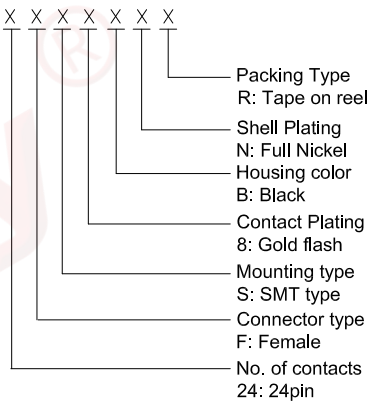

3D View

GENERAL TOLERANCE		ANGLE TOLERANCE		PROJECTION		TITLE	USB C Type 24P Female Upright SMT
X.	±0.60	X.	±5°	UNITS	mm		Type H=12.0mm
.X	±0.38	.X	±3°	SHEET SIZE	A4	SERIES	DS1144-44 SERIES
.XX	±0.25	.XX	±2°				
DRAWING TYPE		CUSTOMER		晨翔电子有限公司 CONNELY CONNELY ELECTRONIC CO. LTD			
SCALE	1:1	SHEET	1 OF 1				
DRAWING NO.	C-DS1144-44-XXXXXX-A						

1 2 3 4 5 6 7 8