

The information provided herein is from CONNELY Electronic Co., Ltd. and is confidential. Any disclosure to a party other than the recipient is prohibited. The intellectual properties and its rights contained herein, including but not limited to, trademarks, patents, copyrights, trade secrets, and technical know-how, are owned exclusively by CONNELY or its affiliates. Unauthorized use of this information in any format or manner. CONNELY may enforce its intellectual property rights at its own discretion; failures or delays to exercise such rights does not constitute a waiver of such rights.

1 2 3 4 5 6 7 8

REV.	DESCRIPTION	DRAWN	CHECKED	APPROVED
A	NEW RELEASE	JLZ 05/02/22'		

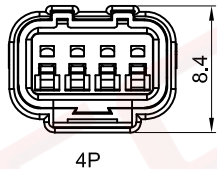
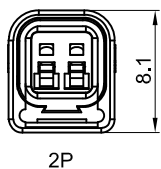
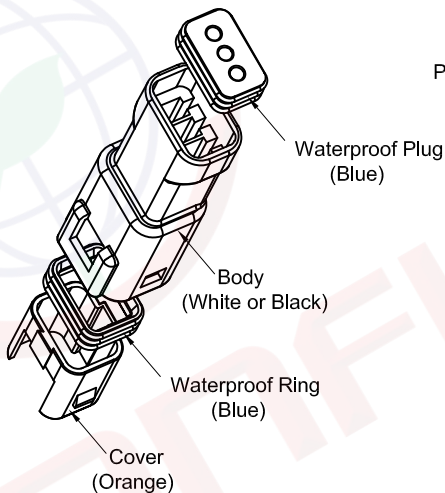
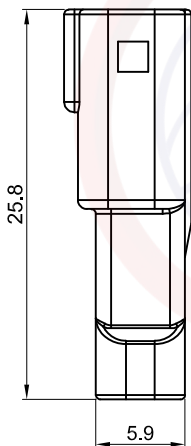
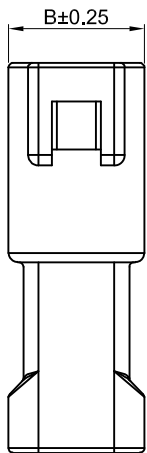
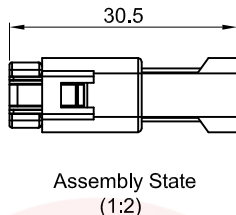
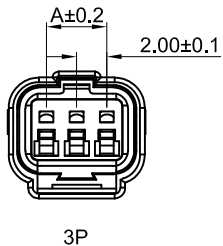

Position	Dimensions(mm)	
	A	B
2P	2.00	7.00
3P	4.00	9.00
4P	6.00	11.00

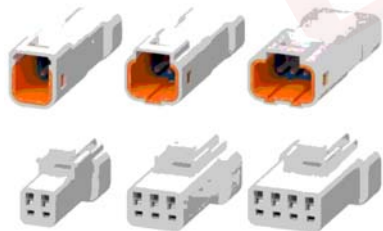

(Series Image-Reference Only)

Notes:

Specifications:

- Contact Resistance: 25mΩ Max.
- Insulation Resistance: 1000MΩ Min.
- Dielectric Withstanding Voltage: 500V AC(rms) For 1 Minute.
- Current Rating:3A.
- Voltage Rating:100V AC rms.
- Temperature: -40°C~+85°C.

Material:

- Body Material: PBT,White or Black.
- Cover Material: PBT,Orange.
- Waterproof Plug: Silicone rubber,Blue.

Product Number Code:

DS1162-02 - X X X X

- Packing Type
P: Polybag
- Housing color
W:White
B: Black
- Mounting type
C: Crimp type
- Connector type
M: Male
- No. of contacts
2: 2Pin 3: 3Pin 4: 4Pin

GENERAL TOLERANCE		ANGLE TOLERANCE	
X.	±0.60	X.	±5°
.X	±0.38	.X	±3°
.XX	±0.25	.XX	±2°

PROJECTION		TITLE	2.00mm Solar Series Connectors
UNITS	mm		Wire to Wire Type
SHEET SIZE	A4	SERIES	DS1162-02 SERIES

DRAWING TYPE	CUSTOMER		
SCALE	1:1	SHEET	1 OF 9
DRAWING NO.	C-DS1162-02-XXXXX-A		

晨翔电子有限公司
CONNELY CONNELY ELECTRONIC CO. LTD

1 2 3 4 5 6 7 8

The information provided herein is from CONNELY Electronic Co., Ltd. and is confidential. Any disclosure to a party other than the recipient is prohibited. The intellectual properties and its rights contained herein, including but not limited to, trademarks, patents, copyrights, trade secrets, and technical know-how, are owned exclusively by CONNELY or its affiliates. Unauthorized use of the information herein, in any format or manner, CONNELY may enforce its intellectual property rights at its own discretion; failures or delays to exercise such rights does not constitute a waiver of such rights.

1 2 3 4 5 6 7 8

REV.	DESCRIPTION	DRAWN	CHECKED	APPROVED
A	NEW RELEASE	JLZ 05/02/22'		

B

C

D

F

F

G

H

H

H

H

H

H

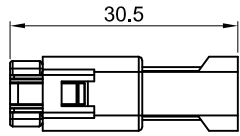

Assembly State
(1:2)

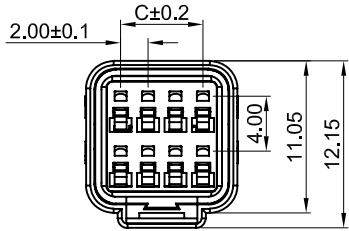

2x4P

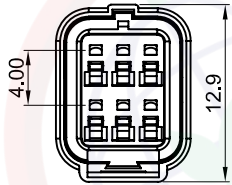

2x3P

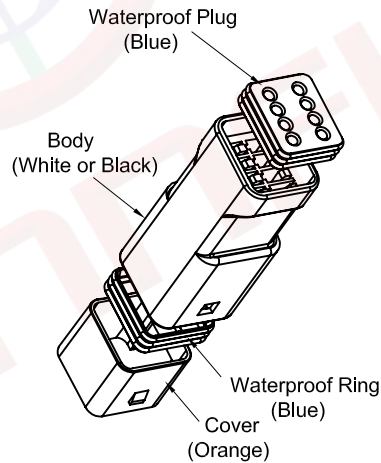
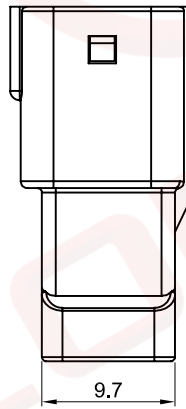
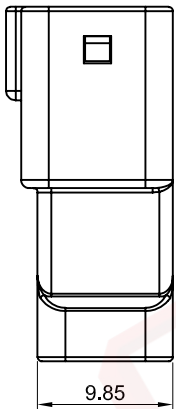
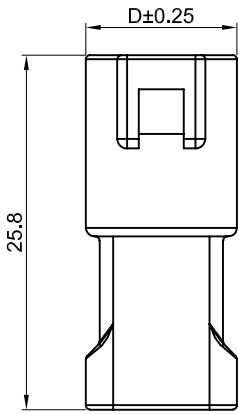

Notes:

Specifications:

- Contact Resistance: 25mΩ Max.
- Insulation Resistance: 1000MΩ Min.
- Dielectric Withstanding Voltage: 500V AC(rms) For 1 Minute.
- Current Rating:3A.
- Voltage Rating:100V AC rms.
- Temperature: -40°C~+85°C.

Material:

- Body Material: PBT,White or Black.
- Cover Material: PBT,Orange.
- Waterproof Plug: Silicone rubber,Blue.

Product Number Code:

DS1162-02 - X X X X

- Packing Type
P: Polybag
- Housing color
W:White
B: Black
- Mounting type
C: Crimp type
- Connector type
M: Male
- No. of contacts
2x3: 2x3Pin 2x4: 2x4Pin

Position	Dimensions(mm)	
	C	D
2x3P	4.00	9.80
2x4P	6.00	11.00

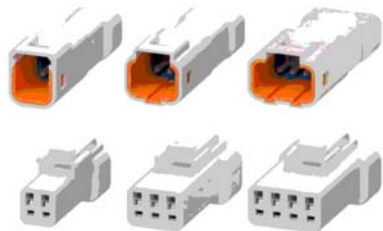

(Series Image-Reference Only)

GENERAL TOLERANCE		ANGLE TOLERANCE	
X.	±0.60	X.	±5°
.X	±0.38	.X	±3°
.XX	±0.25	.XX	±2°

DRAWING TYPE	CUSTOMER		
SCALE	1:1	SHEET	2 OF 9
DRAWING NO.	C-DS1162-02-XXXXX-A		

PROJECTION		TITLE	2.00mm Solar Series Connectors
UNITS	mm		Wire to Wire Type
SHEET SIZE	A4	SERIES	DS1162-02 SERIES

晨翔电子有限公司
CONNFLY CONNELY ELECTRONIC CO. LTD

1 2 3 4 5 6 7 8

The information provided herein is from CONNELY Electronic Co., Ltd. and is confidential. Any disclosure to a party other than the recipient is prohibited. The intellectual properties and its rights contained herein, including but not limited to, trademarks, patents, copyrights, trade secrets, and technical know-how, are owned exclusively by CONNELY or its affiliates. Unauthorized use or reproduction of this document in any format or manner. CONNELY may enforce its intellectual property rights at its own discretion; failures or delays to exercise such rights does not constitute a waiver of such rights.

1 2 3 4 5 6 7 8

Dept	Qty	REV.	DESCRIPTION	DRAWN	CHECKED	APPROVED
DC	1	A	NEW RELEASE	JLZ 05/02/22'		
ED	1					
IE	1					
ISO	1					
PD	1					
R&D	1					
SD	1					
QA	1					
QC	1					
QE	1					

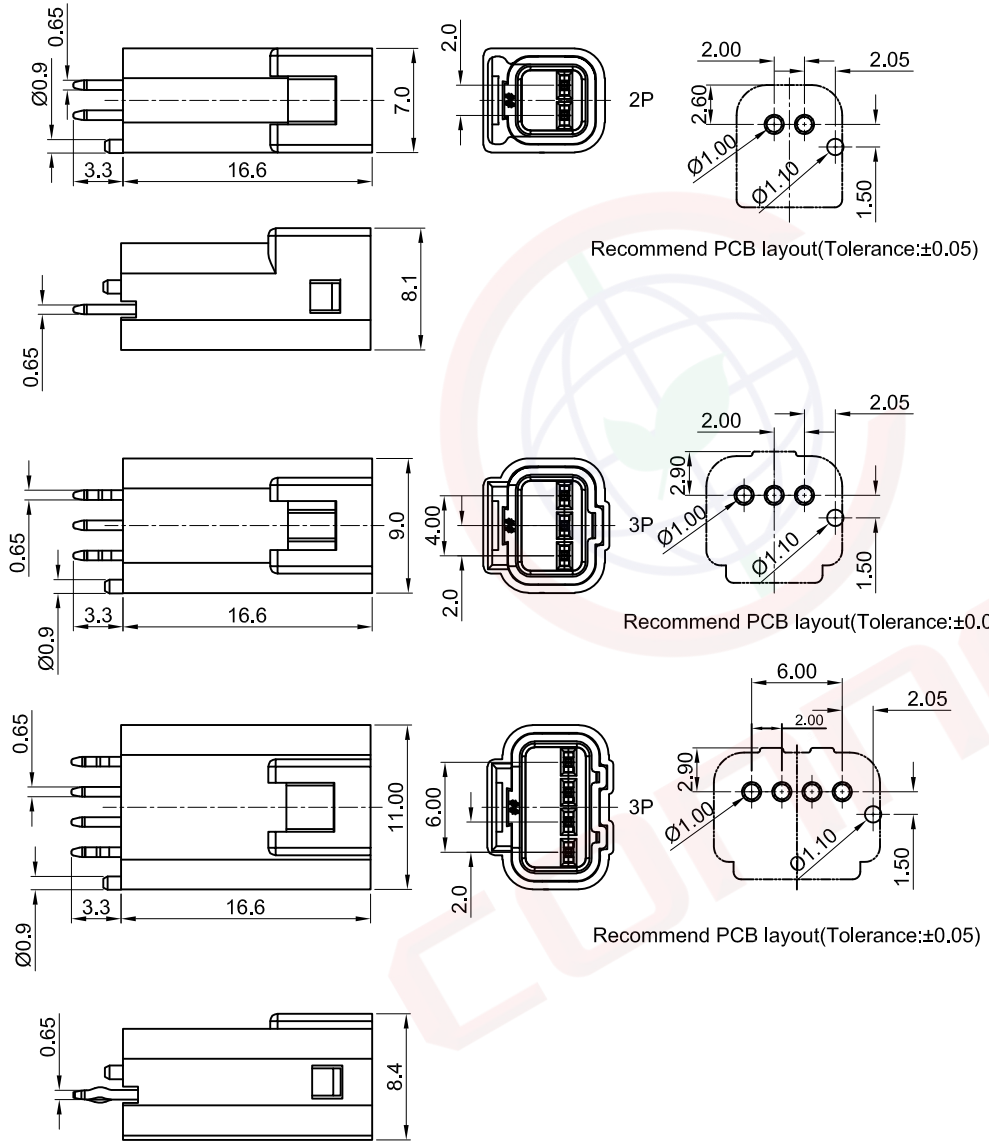

Notes:

Specifications:

- Contact Resistance: 25mΩ Max.
- Insulation Resistance: 1000MΩ Min.
- Dielectric Withstanding Voltage: 500V AC(rms) For 1 Minute.
- Current Rating:3A.
- Voltage Rating:100V AC rms.
- Temperature: -40°C~+85°C.

Material:

- Body Material: PBT,White or Black.
- Cover Material: PBT,Orange.
- Waterproof Plug: Silicone rubber,Blue.

Product Number Code:

DS1162-02 - X X X X X

- Packing Type
P: Polybag
- Housing color
W:White
B: Black
- Mounting type
V: V/T type
- Connector type
M: Male
- No. of contacts
2: 2Pin 3: 3Pin 4: 4Pin

GENERAL TOLERANCE		ANGLE TOLERANCE		PROJECTION		TITLE	2.00mm Solar Series Connectors
X.	±0.60	X.	±5°	UNITS	mm		WTB Type
.X	±0.38	.X	±3°	SHEET SIZE	A4	SERIES	DS1162-02 SERIES
.XX	±0.25	.XX	±2°	晨翔电子有限公司 CONNELY ELECTRONIC CO. LTD			
DRAWING TYPE		CUSTOMER					
SCALE		1:1	SHEET 3 OF 9				
DRAWING NO.		C-DS1162-02-XXXXX-A					

1 2 3 4 5 6 7 8

The information provided herein is from CONNELY Electronic Co., Ltd. and is confidential. Any disclosure to a party other than the recipient is prohibited. The intellectual properties and its rights contained herein, including but not limited to, trademarks, patents, copyrights, trade secrets, and technical know-how, are owned exclusively by CONNELY or its affiliates. Unauthorized use or reproduction of this document in any format or manner. CONNELY may enforce its intellectual property rights at its own discretion; failures or delays to exercise such rights does not constitute a waiver of such rights.

1 2 3 4 5 6 7 8

REV.	DESCRIPTION	DRAWN	CHECKED	APPROVED
A	NEW RELEASE	JLZ 05/02/22'		

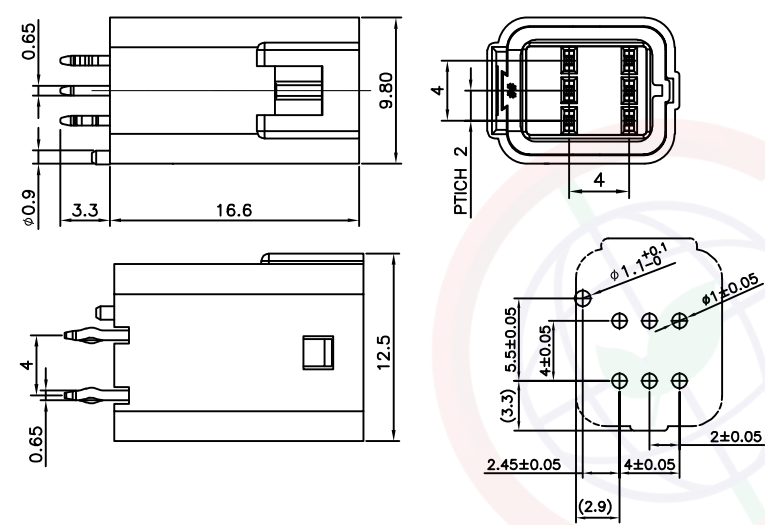

Recommend PCB layout

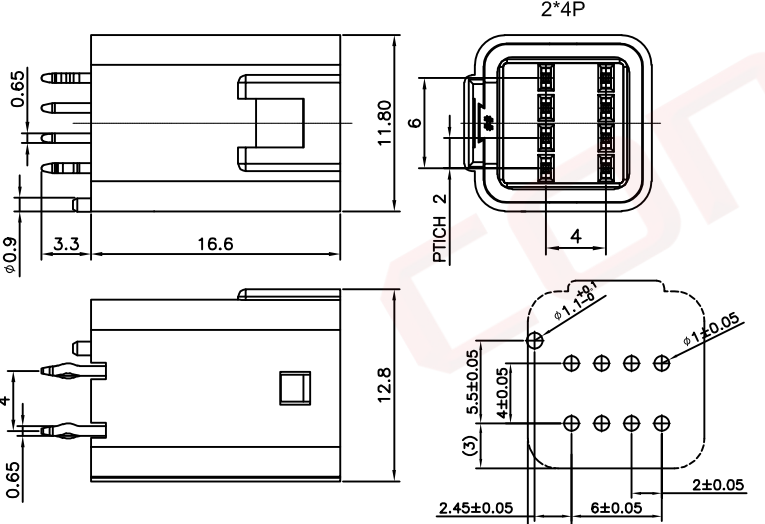

Recommend PCB layout

Notes:

Specifications:

- Contact Resistance: 25mΩ Max.
- Insulation Resistance: 1000MΩ Min.
- Dielectric Withstanding Voltage: 500V AC(rms) For 1 Minute.
- Current Rating:3A.
- Voltage Rating:100V AC rms.
- Temperature: -40°C~+85°C.

Material:

- Body Material: PBT,White or Black.
- Cover Material: PBT,Orange.
- Waterproof Plug: Silicone rubber,Blue.

Product Number Code:

DS1162-02 - X X X X

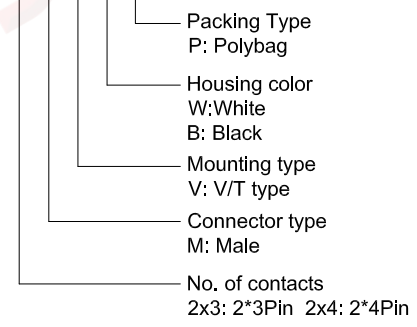

GENERAL TOLERANCE	ANGLE TOLERANCE
X. ±0.60	X. ±5°
.X ±0.38	.X ±3°
.XX ±0.25	.XX ±2°

PROJECTION		TITLE	2.00mm Solar Series Connectors
UNITS	mm		WTB Type
SHEET SIZE	A4	SERIES	DS1162-02 SERIES

DRAWING TYPE	CUSTOMER		
SCALE	1:1	SHEET	4 OF 9
DRAWING NO.	C-DS1162-02-XXXXX-A		

晨翔电子有限公司
CONNELY ELECTRONIC CO. LTD

1 2 3 4 5 6 7 8

The information provided herein is from CONNELY Electronic Co., Ltd. and is confidential. Any disclosure to a party other than the recipient is prohibited. The intellectual properties and its rights contained herein, including but not limited to, trademarks, patents, copyrights, trade secrets, and technical know-how, are owned exclusively by CONNELY or its affiliates. Unauthorized use of this information in any format or manner. CONNELY may enforce its intellectual property rights at its own discretion; failures or delays to exercise such rights does not constitute a waiver of such rights.

1 2 3 4 5 6 7 8

REV.	DESCRIPTION	DRAWN	CHECKED	APPROVED
A	NEW RELEASE	JLZ 05/02/22'		

B
QA 1
QC 1
QF 1

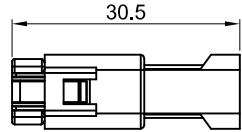

Assembly State
(1:2)

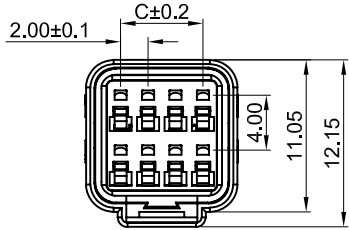

2x4P

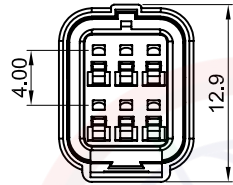

2x3P

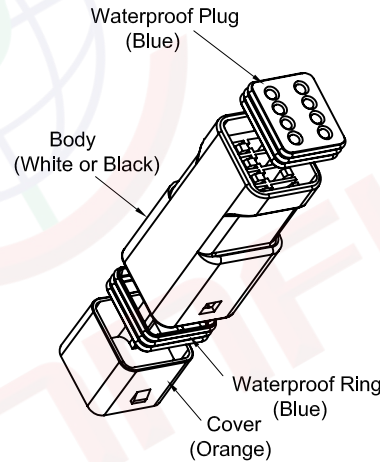
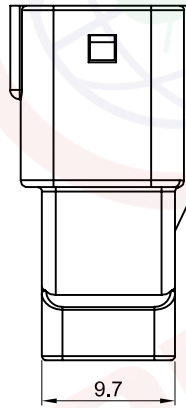
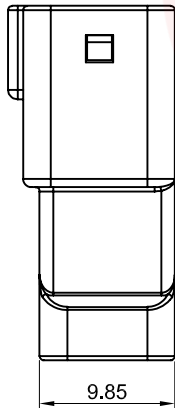
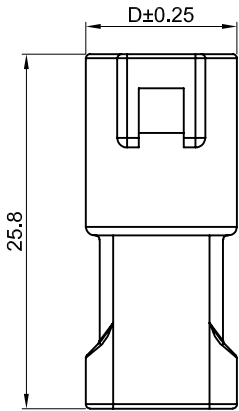

Notes:

Specifications:

- Contact Resistance: 25mΩ Max.
- Insulation Resistance: 1000MΩ Min.
- Dielectric Withstanding Voltage: 500V AC(rms) For 1 Minute.
- Current Rating:3A.
- Voltage Rating:100V AC rms.
- Temperature: -40°C~+85°C.

Material:

- Body Material: PBT,White or Black.
- Cover Material: PBT,Orange.
- Waterproof Plug: Silicone rubber,Blue.

Product Number Code:

DS1162-02 - X X X X

- Packing Type
P: Polybag
- Housing color
W:White
B: Black
- Mounting type
C: Crimp type
- Connector type
M: Male
- No. of contacts
2x3: 2x3Pin 2x4: 2x4Pin

Position	Dimensions(mm)	
	C	D
2x3P	4.00	9.80
2x4P	6.00	11.00

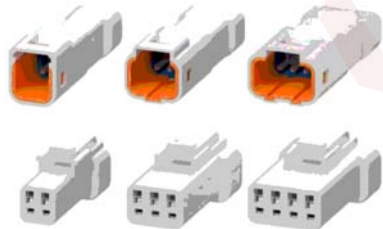

(Series Image-Reference Only)

GENERAL TOLERANCE		ANGLE TOLERANCE	
X.	±0.60	X.	±5°
.X	±0.38	.X	±3°
.XX	±0.25	.XX	±2°

PROJECTION		TITLE	2.00mm Solar Series Connectors
UNITS	mm		Wire to Wire Type
SHEET SIZE	A4	SERIES	DS1162-02 SERIES

DRAWING TYPE	CUSTOMER		
SCALE	1:1	SHEET	5 OF 9
DRAWING NO.	C-DS1162-02-XXXXX-A		

晨翔电子有限公司
CONNELY CONNELY ELECTRONIC CO. LTD

1 2 3 4 5 6 7 8

The information provided herein is from CONNELY Electronic Co., Ltd. and is confidential. Any disclosure to a party other than the recipient is prohibited. The intellectual properties and its rights contained herein, including but not limited to, trademarks, patents, copyrights, trade secrets, and technical know-how, are owned exclusively by CONNELY or its affiliates. Unauthorized use of this information in any format or manner. CONNELY may enforce its intellectual property rights at its own discretion; failures or delays to exercise such rights does not constitute a waiver of such rights.

1 2 3 4 5 6 7 8

REV.	DESCRIPTION	DRAWN	CHECKED	APPROVED
A	NEW RELEASE	JLZ 05/02/22'		

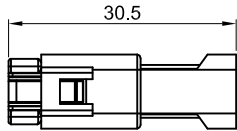

Assembly State
(1:2)

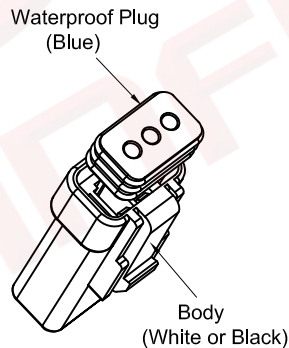
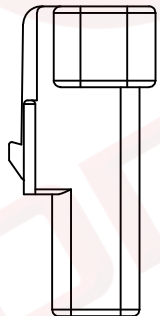
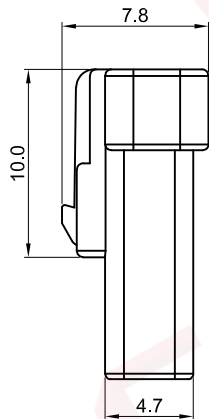
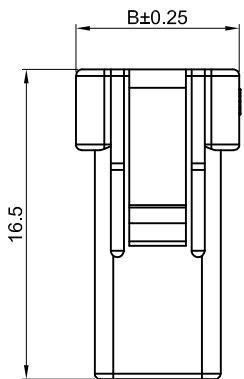
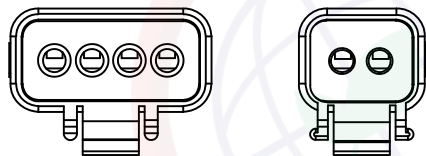
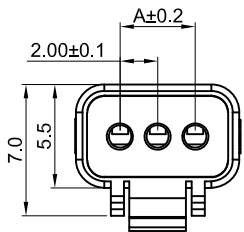

Notes:

Specifications:

- Contact Resistance: 25mΩ Max.
- Insulation Resistance: 1000MΩ Min.
- Dielectric Withstanding Voltage: 500V AC(rms) For 1 Minute.
- Current Rating:3A.
- Voltage Rating:100V AC rms.
- Temperature: -40°C~+85°C.

Material:

- Body Material: PBT,White or Black.
- Cover Material: PBT,Orange.
- Waterproof Plug: Silicone rubber,Blue.

Product Number Code:

DS1162-02 - X X X X

- Packing Type
P: Polybag
- Housing color
W:White
B: Black
- Mounting type
C: Crimp type
- Connector type
F: Female
- No. of contacts
2: 2Pin 3: 3Pin 4: 4Pin

Position	Dimensions(mm)	
	A	B
2P	2.00	6.70
3P	4.00	8.70
4P	6.00	10.70

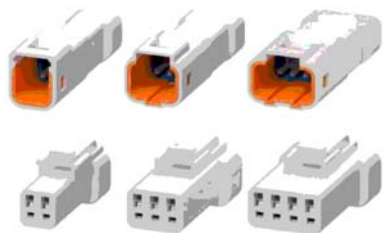

(Series Image-Reference Only)

GENERAL TOLERANCE		ANGLE TOLERANCE		PROJECTION		TITLE	2.00mm Solar Series Connectors Wire to Wire Type		
X.	±0.60	X.	±5°	UNITS	mm	SHEET SIZE	A4		
.X	±0.38	.X	±3°			SERIES	DS1162-02 SERIES		
.XX	±0.25	.XX	±2°						
DRAWING TYPE		CUSTOMER		晨翔电子有限公司 CONNELY ELECTRONIC CO. LTD					
SCALE		1:1						SHEET	6 OF 9
DRAWING NO.		C-DS1162-02-XXXXX-A							

1 2 3 4 5 6 7 8

The information provided herein is from CONNELY Electronic Co., Ltd. and is confidential. Any disclosure to a party other than the recipient is prohibited. The intellectual properties and its rights contained herein, including but not limited to, trademarks, patents, copyrights, trade secrets, and technical know-how, are owned exclusively by CONNELY or its affiliates. Unauthorized use of this information in any format or manner. CONNELY may enforce its intellectual property rights at its own discretion; failures or delays to exercise such rights does not constitute a waiver of such rights.

1 2 3 4 5 6 7 8

REV.	DESCRIPTION	DRAWN	CHECKED	APPROVED
A	NEW RELEASE	JLZ 05/02/22'		

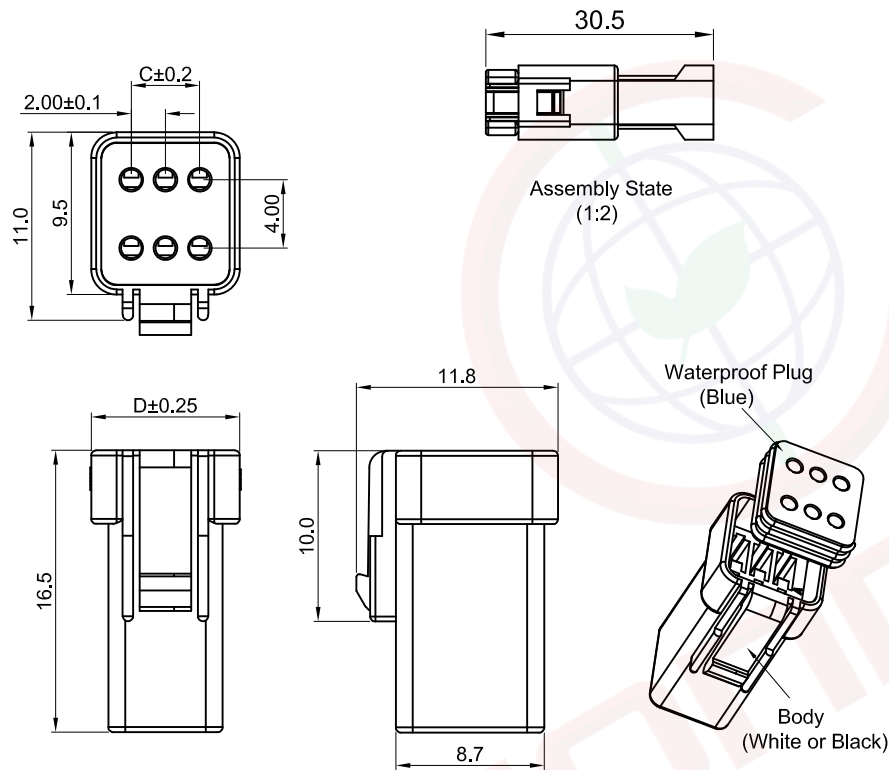

Notes:

Specifications:

- Contact Resistance: 25mΩ Max.
- Insulation Resistance: 1000MΩ Min.
- Dielectric Withstanding Voltage: 500V AC(rms) For 1 Minute.
- Current Rating:3A.
- Voltage Rating:100V AC rms.
- Temperature: -40°C~+85°C.

Material:

- Body Material: PBT,White or Black.
- Cover Material: PBT,Orange.
- Waterproof Plug: Silicone rubber,Blue.

Product Number Code:

DS1162-02 - X X X X

- Packing Type
P: Polybag
- Housing color
W:White
B: Black
- Mounting type
C: Crimp type
- Connector type
F: Fmale
- No. of contacts
2x3: 2x3Pin 2x4: 2x4Pin

Position	Dimensions(mm)	
	C	D
2x3P	4.00	8.70
2x4P	6.00	10.70

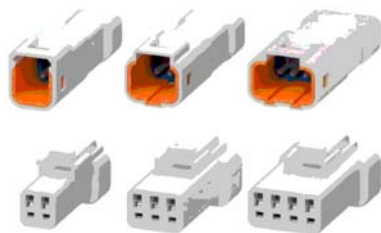

(Series Image-Reference Only)

GENERAL TOLERANCE	ANGLE TOLERANCE	PROJECTION		TITLE	2.00mm Solar Series Connectors Wire to Wire Type
X. ±0.60	X. ±5°	UNITS	mm	SHEET SIZE	A4
.X ±0.38	.X ±3°			SERIES	DS1162-02 SERIES
.XX ±0.25	.XX ±2°				
DRAWING TYPE	CUSTOMER	晨翔电子有限公司 CONNELY CONNELY ELECTRONIC CO. LTD			
SCALE	1:1 SHEET 7 OF 9				
DRAWING NO.	C-DS1162-02-XXXXX-A				

1 2 3 4 5 6 7 8

The information provided herein is from CONNELY Electronic Co., Ltd. and is confidential. Any disclosure to a party other than the recipient is prohibited. The intellectual properties and its rights contained herein, including but not limited to, trademarks, patents, copyrights, trade secrets, and technical know-how, are owned exclusively by CONNELY or its affiliates. Unauthorized use of this information in any format or manner. CONNELY may enforce its intellectual property rights at its own discretion; failures or delays to exercise such rights does not constitute a waiver of such rights.

1 2 3 4 5 6 7 8

REV.	DESCRIPTION	DRAWN	CHECKED	APPROVED
A	NEW RELEASE	JLZ 05/02/22'		

A B C D E F G H

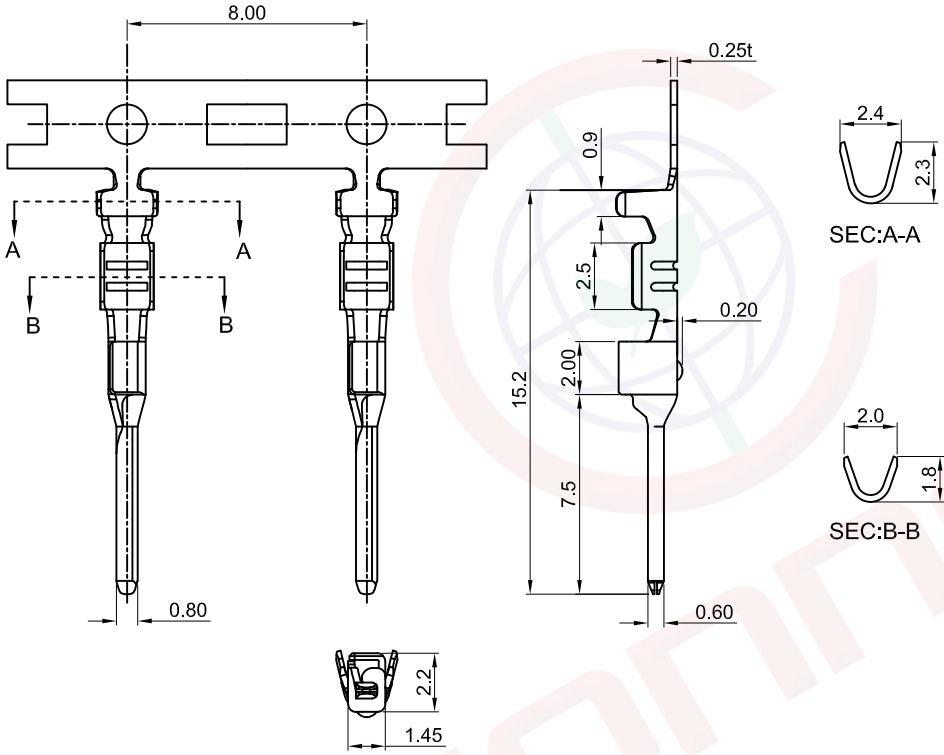

Notes:
 Specifications:
 1. Contact Resistance: 25mΩ Max.
 2. Wire Range: AWG#22-#24.
 3. Insultion O.D:1.7mm Max.
 Material:
 1. Contact Material: Copper Alloy.
 Product Number Code:

T - DS1162-02 - P C X 00

- Contact plating
- 6: Tin
- 8:Gold flash
- Mounting type
- C: Crimp type
- Contact type
- P: Plug



(Series Image-Reference Only)

GENERAL TOLERANCE		ANGLE TOLERANCE		PROJECTION		TITLE	2.00mm Solar Series Connectors Wire to Wire Type
X.	±0.60	X.	±5°	UNITS	mm	SHEET	8 OF 9
.X	±0.38	.X	±3°	SHEET SIZE	A4	SERIES	DS1162-02 SERIES
.XX	±0.25	.XX	±2°	晨翔电子有限公司 CONNELY CONNELY ELECTRONIC CO. LTD			
DRAWING TYPE		CUSTOMER					
SCALE		1:1	SHEET				
DRAWING NO.		C-DS1162-02-XXXXX-A					

1 2 3 4 5 6 7 8

The information provided herein is from CONNELY Electronic Co., Ltd. and is confidential. Any disclosure to a party other than the recipient is prohibited. The intellectual properties and its rights contained herein, including but not limited to, trademarks, patents, copyrights, trade secrets, and technical know-how, are owned exclusively by CONNELY or its affiliates. Unauthorized use of this information in any format or manner. CONNELY may enforce its intellectual property rights at its own discretion; failures or delays to exercise such rights does not constitute a waiver of such rights.

1 2 3 4 5 6 7 8

REV.	DESCRIPTION	DRAWN	CHECKED	APPROVED
A	NEW RELEASE	JLZ 05/02/22'		

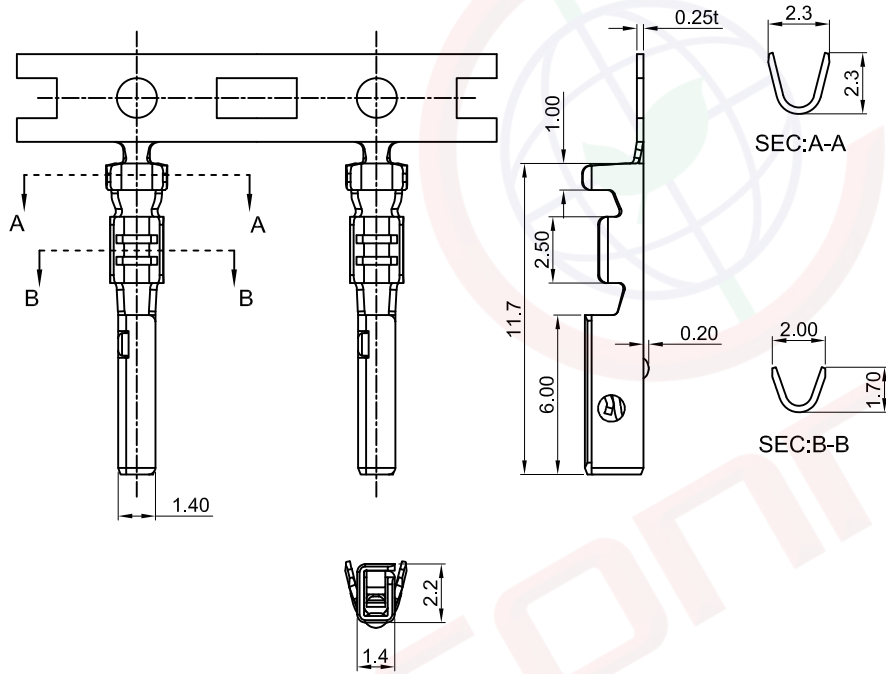

Notes:
 Specifications:
 1. Contact Resistance: 25mΩ Max.
 2. Wire Range: AWG#22-#24.
 3. Insultion O.D:1.7mm Max.

Material:
 1. Contact Material: Copper Alloy.
 Product Number Code:

T - DS1162-02 - S C X 00

- S: Contact plating
- 6: Tin
- 8: Gold flash
- C: Mounting type
- C: Crimp type
- S: Contact type
- S: Socket



(Series Image-Reference Only)

GENERAL TOLERANCE		ANGLE TOLERANCE	
X.	±0.60	X.	±5°
.X	±0.38	.X	±3°
.XX	±0.25	.XX	±2°

PROJECTION		TITLE	2.00mm Solar Series Connectors
UNITS	mm		Wire to Wire Type
SHEET SIZE	A4	SERIES	DS1162-02 SERIES

DRAWING TYPE	CUSTOMER		
SCALE	1:1	SHEET	9 OF 9
DRAWING NO.	C-DS1162-02-XXXXX-A		

晨翔电子有限公司
CONNFLY CONNELY ELECTRONIC CO. LTD

1 2 3 4 5 6 7 8