

此處提供的信息來自寧波晨翔電子有限公司並且是保密的。禁止向收件人以外的任何一方披露信息。本文包含的知識產權及其權利（包括但不限於商標、專利、版權、商業秘密和技术知识）均由晨翔或其附屬公司擁有。未經晨翔事先書面同意，嚴禁未經授權的使用或修改。此處提供的知識產權僅供參考，並不構成以任何形式或方式使用其權利。晨翔可以自行決定強制執行其知識產權；不願行或延遲行使其權利並不構成對這些權利的放棄。

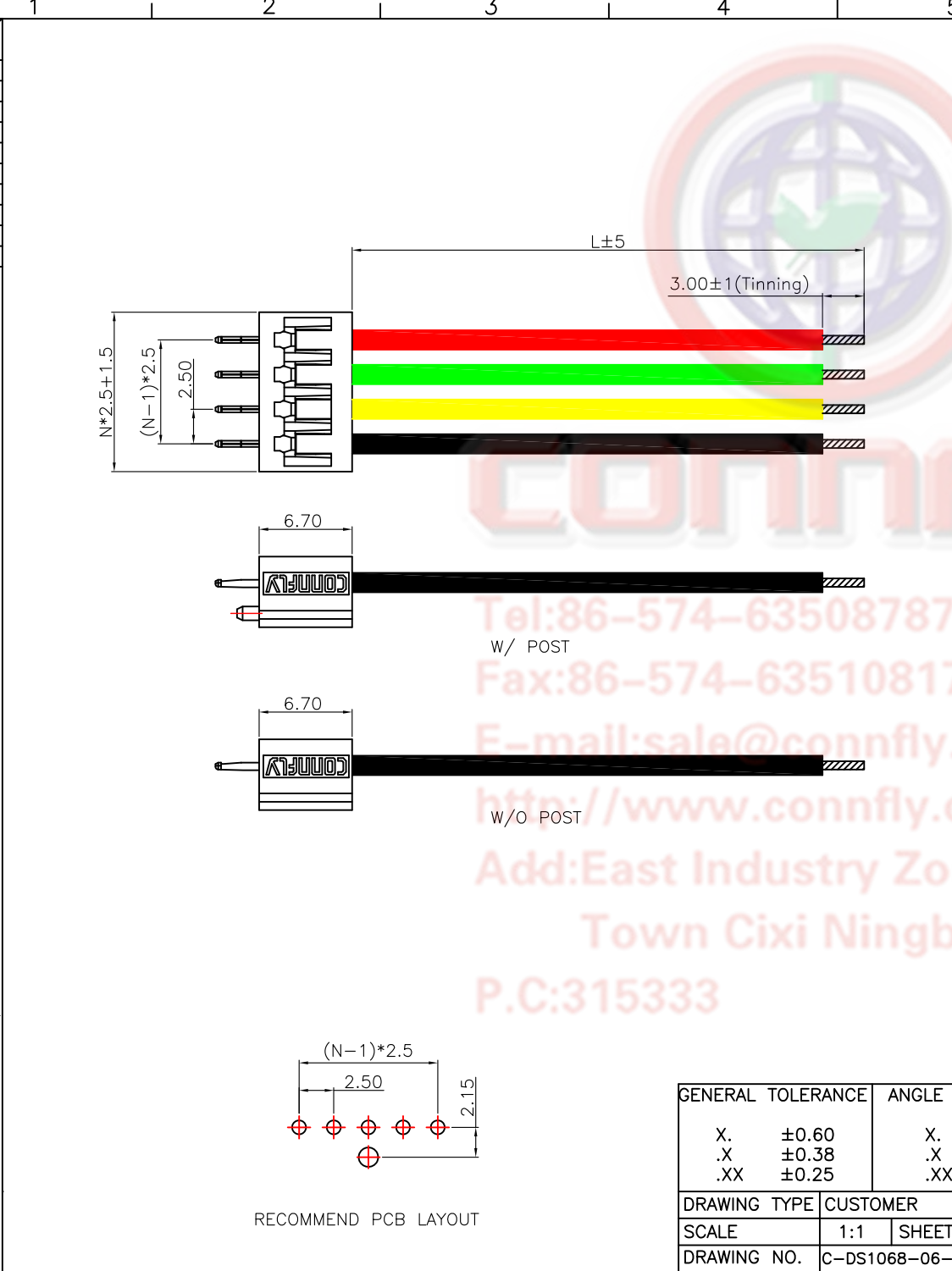

REV.	DESCRIPTION	DRAWN	CHECKED	APPROVED
A	NEW RELEASE	JLZ 08/02/18'		

- NOTES:
- Materials:
    - 1.1 Housing material: NYLON 66
    - 1.2 Contact: Copper Alloy
    - 1.3 Wire Insulator: PVC
    - 1.4 Wire: Tin Plated Copper
  - Specifications:
    - 2.1 Current Rating: 2A
    - 2.2 Voltage Rating: 250V AC/DC
    - 2.3 Contact Resistance: 2Ω Max.
    - 2.4 Insulation resistance: 500MΩ Min.
    - 2.5 Wire Range: UL1007 AWG#22~26
  - Product Number Code:
    - DS1068-06 - X X X X X X X X
- POST SUPPORT  
 S: W/ POST  
 X: W/O POST
- WIRE LENGTH(Dim L)  
 080: 80mm  
 180: 180mm .....
- HOUSING COLOR  
 W: White
- CONTACT PLATING  
 6: Full Tin
- MOUNTING TYPE  
 C: Crimp
- WIRE GAUGE  
 26: AWG #26 24: AWG #24  
 22: AWG #22
- CONNECTOR TYPE  
 F: Female
- No.OF CONTACTS  
 03~10

Tel:86-574-63508787  
 Fax:86-574-63510817  
 E-mail:sale@connfly.com  
 http://www.connfly.com  
 Add:East Industry Zone KuangYan  
 Town Cixi Ningbo China  
 P.C:315333

GENERAL TOLERANCE		ANGLE TOLERANCE		PROJECTION	TITLE
X.	±0.60	X.	±5°		2.5mm NEW SCN W/ Fool-proof Crimp Type
.X	±0.38	.X	±3°	mm	
.XX	±0.25	.XX	±2°	A4	SERIES DS1068-06 SERIES
DRAWING TYPE		CUSTOMER		<b>晨翔电子有限公司</b> <b>CONNFLY CONNFLY ELECTRONIC CO. LTD</b>	
SCALE		1:1 SHEET 1 OF 1			
DRAWING NO.		C-DS1068-06-XXXXXXXX-A			

The information provided herein is from CONNELY Electronic Co., Ltd. and is confidential. Any disclosure to a party other than the recipient is prohibited. The intellectual properties and its rights contained herein, including but not limited to, trademarks, patents, copyrights, trade secrets, and technical know-how, are owned exclusively by CONNELY or its affiliates. Unauthorized use of this information in any format or manner. CONNELY may enforce its intellectual property rights at its own discretion; failures or delays to exercise such rights does not constitute a waiver of such rights.

1      2      3      4      5      6      7      8

REV.	DESCRIPTION	DRAWN	CHECKED	APPROVED
A	NEW RELEASE	JLZ 08/02/18'		

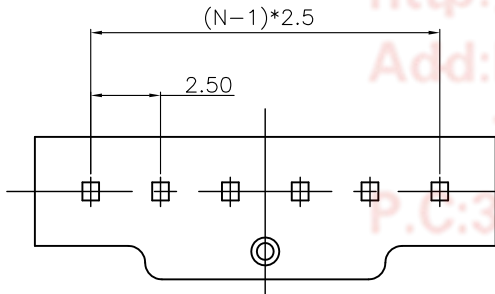
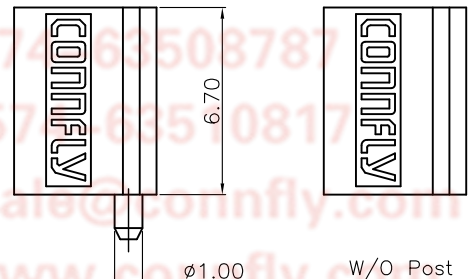
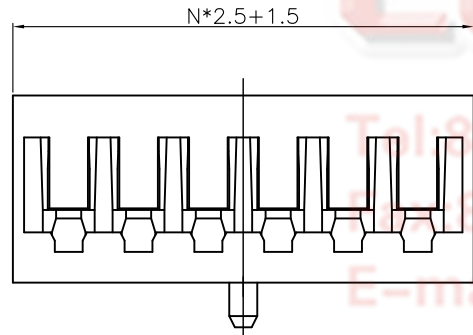
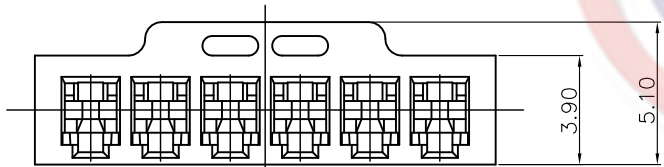

NOTES:

1. MATERIAL
  - 1.1 INSULATOR:THERMOPLASTIC.
2. SPECIFICATION
  - 2.1 TEMPERATURE:-20~+85°C.
  - 2.2 INSULATION RESISTANCE:500MΩ min.
  - 2.3 DIELECTRIC WITHSTANDING VOLTAGE:AC 250V PER MINUTE.
3. P/N CODE:

I - DS1068-06 - S C W 0 X - X

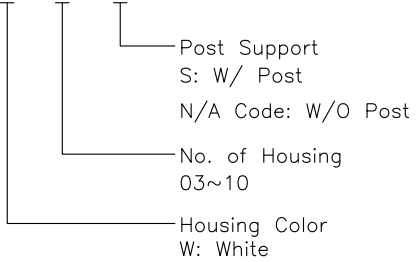

Tel:86-574-63508787  
 Fax:86-574-63510817  
 E-mail:sales@connfly.com  
 http://www.connfly.com  
 Add:East Industry Zone KuangYan  
 Town Cixi Ningbo China  
 P.C:315333

GENERAL TOLERANCE		ANGLE TOLERANCE		PROJECTION		TITLE	2.5mm New SCN Type Housing		
X.	±0.60	X.	±5°	UNITS	mm	SHEET SIZE	A4	SERIES	DS1068-06 SERIES
.X	±0.38	.X	±3°	晨翔电子有限公司 <b>CONNELY CONNELY ELECTRONIC CO. LTD</b>					
.XX	±0.25	.XX	±2°						
DRAWING TYPE		CUSTOMER		SCALE					
SCALE		1:1		SHEET		1 OF 1			
DRAWING NO.		I-DS1068-06-SCW0X-X-A							

1      2      3      4      5      6      7      8

Dept  
 Qty  
 DC 1  
 ED 1  
 IE 1  
 ISO 1  
 PD 1  
 R&D 1  
 SD 1  
 QA 1  
 QC 1  
 QF 1  
 The information provided herein is from CONNELY Electronic Co., Ltd. and is confidential. Any disclosure to a party other than the recipient is prohibited. The intellectual properties and its rights contained herein, including but not limited to, trademarks, patents, copyrights, trade secrets, and technical know-how, are owned exclusively by CONNELY or its affiliates. Unauthorized use of the information herein is strictly prohibited. CONNELY may enforce its intellectual property rights at its own discretion; failures or delays to exercise such rights does not constitute a waiver of such rights.

REV.	DESCRIPTION	DRAWN	CHECKED	APPROVED
A	NEW RELEASE	JLZ 08/17/18'		

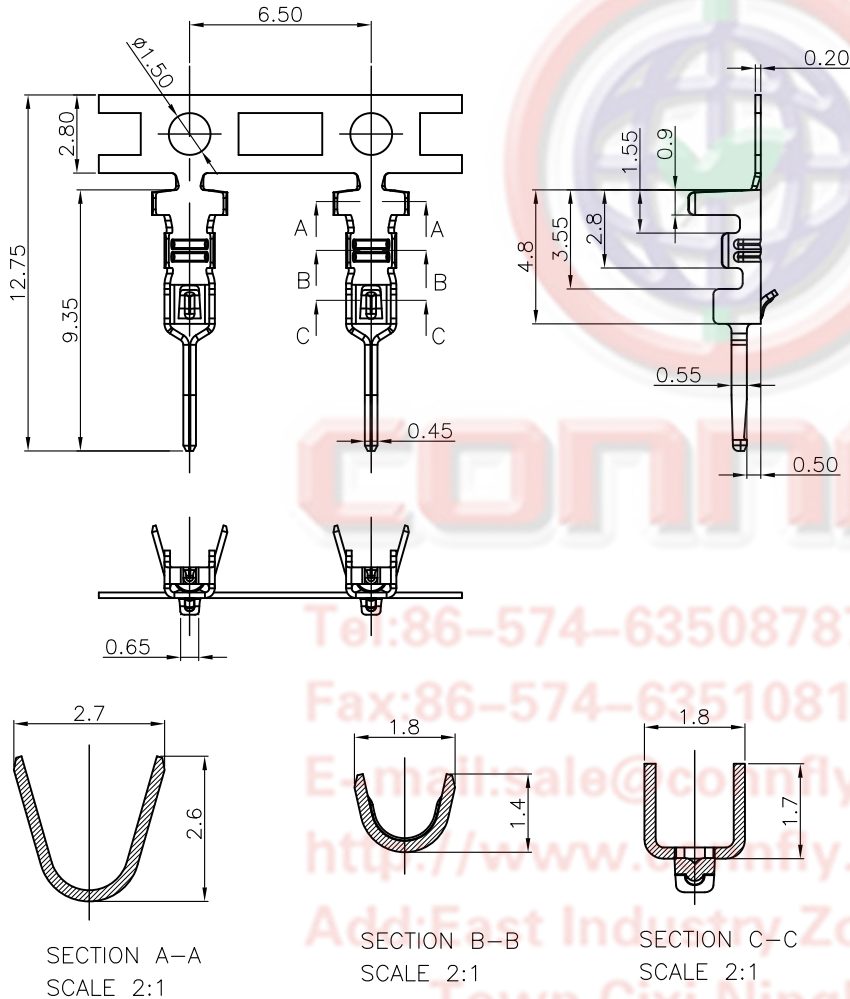

Notes:  
 1.Materials: Copper Alloy.  
 2.Packing Type: Reel Paperl.  
 3.Part Number Code:  
 T - DS1068-06 - S C X 0 0  
 Plating:  
 6: Full Tin

Tel:86-574-63508787  
 Fax:86-574-63510817  
 E-mail:sale@connely.com  
 http://www.connely.com  
 Add:East Industry Zone KuangYan  
 Town Cixi Ningbo China  
 P.C:315333

GENERAL TOLERANCE		ANGLE TOLERANCE		PROJECTION		TITLE
X.	±0.60	X.	±5°	UNITS	mm	2.5mm New SCN Type Terminal
.X	±0.38	.X	±3°	SHEET SIZE	A4	SERIES DS1068-06 SERIES
.XX	±0.25	.XX	±2°	晨翔电子有限公司 <b>CONNELY CONNELY ELECTRONIC CO. LTD</b>		
DRAWING TYPE		CUSTOMER				
SCALE		1:1	SHEET 1 OF 1			
DRAWING NO.		T-DS1068-06-SCX00-A				