

The information provided herein is from CONNELY Electronic Co., Ltd. and is confidential. Any disclosure to a party other than the recipient is prohibited. The intellectual properties and its rights contained herein, including but not limited to, trademarks, patents, copyrights, trade secrets, and technical know-how, are owned exclusively by CONNELY or its affiliates. Unauthorized use of this information in any format or manner, CONNELY may enforce its intellectual property rights at its own discretion; failures or delays to exercise such rights does not constitute a waiver of such rights.

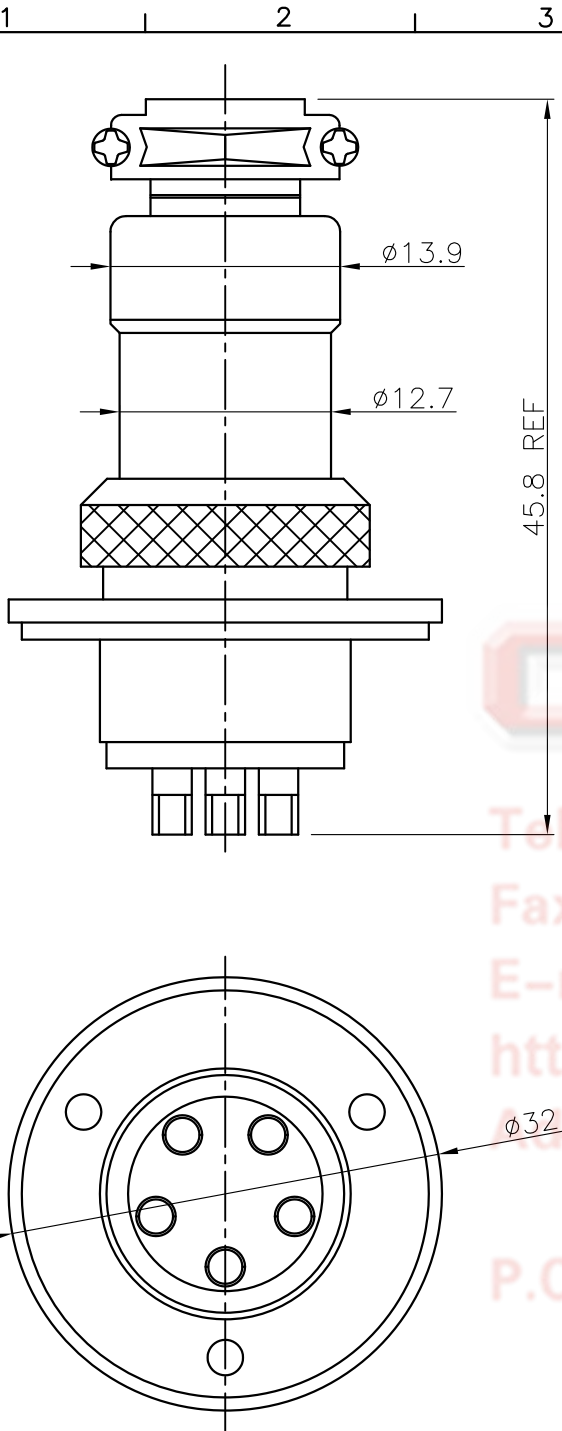

REV.	DESCRIPTION	DRAWN	CHECKED	APPROVED
A	NEW RELEASE	LL 07/18/06'		LJC 07/18/06'
B	DRAWING UPDATE	JLZ 12/20/16'	HZW 12/20/16'	LJC 12/20/16'
C	DRAWING UPDATE	JLZ 11/10/18'		

NOTES:

- SPECIFICATION
 - CURRENT RATING: 5A Max.
 - DIELECTRIC WITH STANDING VOLTAGE: 500V(AC)
 - CONTACT RESISTANCE: 100mΩ Max.
 - INSULATION RESISTANCE: 1000MΩ(DC)Min.
- PRODUCT NUMBER CODE:

DS1110-02 - X X X

CONTACT PLATING
6: SILVER

COLOR OF HOUSING:
W: WHITE
B: BLACK

No. OF CONTACTS
2~10pin

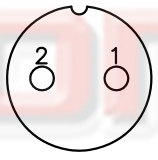

2 PIN

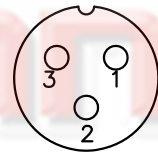

3 PIN

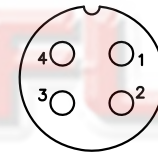

4 PIN

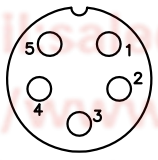

5 PIN

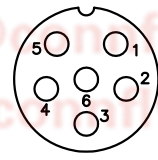

6 PIN

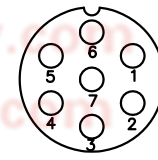

7 PIN

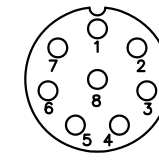

8 PIN

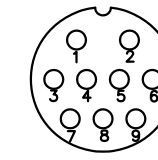

9 PIN

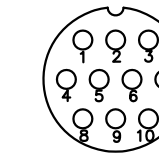

10 PIN

Tel:86-574-63508787
 Fax:86-574-63510817
 E-mail:sales@connely.com
 http://www.connely.com
 Add:East Industry Zone KuangYan
 Town Cixi Ningbo China
 P.C:315333

GENERAL TOLERANCE		ANGLE TOLERANCE	
X.	±0.60	X.	±5°
.X	±0.38	.X	±3°
.XX	±0.25	.XX	±2°

PROJECTION		TITLE	MICRO JACK CONNECTOR
UNITS	mm	SHEET	1 OF 1
SHEET SIZE	A4	SERIES	DS1110-02 SERIES

DRAWING TYPE	CUSTOMER		
SCALE	1:1	SHEET	1 OF 1
DRAWING NO.	C-DS1110-02-XXX-C		

晨翔电子有限公司
CONNELY CONNELY ELECTRONIC CO. LTD